

# MAGNAVOX

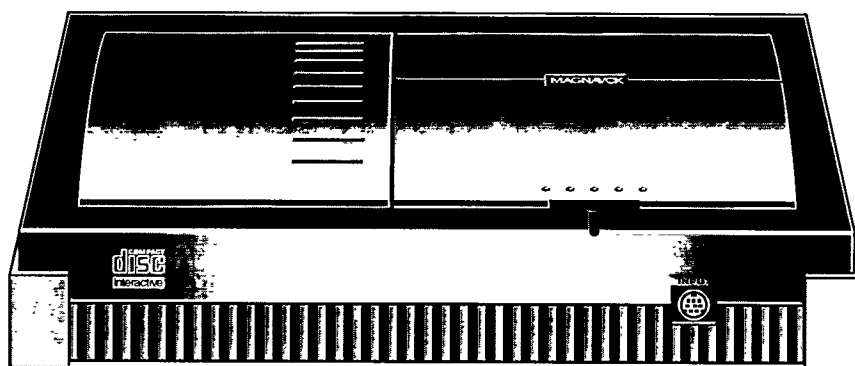

CDI450 / CDI550

Operating Instructions



**Please Follow These Three  
Important Steps To Get The  
Most From Your Product**

**RETURN YOUR OWNER'S  
REGISTRATION CARD WITHIN  
10 DAYS.**

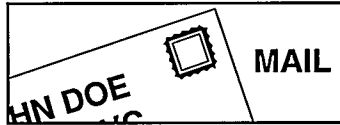

Registering your purchase is an essential step to guarantee that you'll receive all of the benefits you're entitled to as a MAGNAVOX product owner. Complete and mail your Owner's Registration Card today to ensure your right to warranty verification, owner confirmation, model registration, plus a wide variety of special services and savings.

**KNOW THESE SAFETY  
SYMBOLS.**



 This "bolt of lightning" indicates uninsulated material within your unit may cause an electrical shock. For the safety of everyone in your household, please do not remove product covering.

 The "exclamation point" calls attention to features for which you should read the enclosed literature closely to prevent operating and maintenance problems.

**READ OPERATING  
INSTRUCTIONS CAREFULLY.**



The information in this manual can help you take full advantage of your product's many features, and ensure years of safe, reliable operation. So don't miss out. Read the enclosed instructions, safety tips and warranty information today.

# MAGNAVOX

**Congratulations On Your New  
Purchase ... And Welcome To  
The MAGNAVOX Family!**

Dear MAGNAVOX Family Member:

Thank you for your confidence in MAGNAVOX. You've selected one of the best-built, best-backed products available today.

We appreciate your support, and we'll do everything we can do to keep you happy with your purchase for many years to come. After all, you're the reason we're in business!

As a MAGNAVOX family member, you're entitled to a world of special privileges – and our uncompromising commitment to your total satisfaction. Your MAGNAVOX product is protected by one of the most comprehensive warranties and outstanding service networks in the industry.

What's more, your purchase qualifies you to receive advance information on exciting new products from MAGNAVOX, convenient access to our home shopping network for special products and accessories, plus factory-direct rebates and discounts on your future MAGNAVOX purchases.

All of this is our way of saying "thanks" for joining the MAGNAVOX family.

To start taking advantage of these great benefits, just remember to return your MAGNAVOX Owner's Registration Card.

Simply complete, detach and mail us your Owner's Registration Card today. And enjoy your new purchase with our best wishes!

Sincerely,

Donald F. Johnstone  
President and Chief Executive Officer

**For Customer Use:**

Enter below the Serial No. which is located on the rear of the cabinet. Retain this information for future reference.

Model No.: CDI450 / CDI550 \_\_\_\_\_

Serial No.: \_\_\_\_\_

# Safety Precautions

**WARNING: TO PREVENT FIRE OR SHOCK HAZARD, DO NOT EXPOSE THIS EQUIPMENT TO RAIN OR MOISTURE.**

**CAUTION:** TO PREVENT ELECTRIC SHOCK, MATCH WIDE BLADE OF PLUG TO WIDE SLOT, FULLY INSERT.

**ATTENTION:** POUR EVITER LES CHOCS ÉLECTRIQUE, INTRODUIRE LA LAME LA PLUS LARGE DE LA FICHE DANS LA BORNE CORRESPONDANTE DE LA PRISE ET POUSSER JUSQU'AU FOND.

**LASER SAFETY:** This unit employs a laser. Only a qualified service person should remove the cover or attempt to service this device, due to possible eye injury.

**CAUTION:** USE OF CONTROLS OR ADJUSTMENTS OR PERFORMANCE OF PROCEDURES OTHER THAN THOSE SPECIFIED HEREIN MAY RESULT IN HAZARDOUS RADIATION EXPOSURE.

THIS DIGITAL APPARATUS DOES NOT EXCEED THE CLASS B LIMITS FOR RADIO NOISE EMISSIONS FROM DIGITAL APPARATUS AS SET OUT IN THE RADIO INTERFERENCE REGULATIONS OF THE CANADIAN DEPARTMENT OF COMMUNICATIONS.

CET APPAREIL NUMÉRIQUE N'ÉMET PAS DE BRUITS RADIOÉLECTRIQUES DÉPASSANT LES LIMITES APPLICABLES DANS LA RÈGLEMENT SUR LE BROUILLAGE RADIOÉLECTRIQUES ÉDICTÉ PAR LE MINISTÈRE DES COMMUNICATIONS DU CANADA.

**CLASS 1  
LASER PRODUCT**

## **WARNING:**

This device complies with Part 15 of the FCC (U.S.A.) Rules. Operation is subject to the following two conditions: (1) this device may not cause harmful interference, and (2) this device must accept any interference received, including interference that may cause undesired operation.

## **NOTE:**

This equipment has been tested and found to comply with the limits for a Class B digital device, pursuant to Part 15 of the FCC Rules. These limits are designed to provide reasonable protection against harmful interference in a residential installation! This equipment generates, uses and can radiate radio frequency energy and, if not installed and used in accordance with the instructions, may cause harmful interference to radio communications. However, there is no guarantee that interference will not occur in a particular installation. If this equipment does cause harmful interference to radio or television reception, which can be determined by turning the equipment off and on, the user is encouraged to try to correct the interference by one or more of the following measures:

- Reorient or relocate the receiving antenna.
- Increase the separation between the equipment and receiver.
- Connect the equipment into an outlet on a circuit different from that to which the receiver is connected.
- Consult the dealer or an experienced radio/TV technician for help.

## **IMPORTANT:**

This product was FCC verified under test conditions that included use of shielded cables and connectors between system components. It is important that you use shielded cables to reduce the possibility of causing interference to radios, television sets, and other electronic devices. If you have any problems, contact your dealer.

Any change or modifications to the equipment by the user not expressly approved by the grantee or manufacturer could void the user's authority to operate such equipment.

## **NOTE TO CATV SYSTEM INSTALLER:**

This reminder is provided to call the CATV (Cable-TV) system installer's attention to Article 820-40 of the NEC that provides guidelines for proper grounding and, in particular, specifies that the cable ground shall be connected to the grounding system of the building, as close to the point of cable entry as practical.

# IMPORTANT SAFETY INSTRUCTIONS

1. Read Instructions - All the safety and operating instructions should be read before the appliance is operated.

2. Retain Instructions - The safety and operating instructions should be retained for future reference.

3. Heed Warnings - All warnings on the appliance and in the operating instructions should be adhered to.

4. Follow Instructions - All operating and use instructions should be followed.

5. Cleaning - Unplug this product from the wall outlet before cleaning. Do not use liquid cleaners or aerosol cleaners. Use a damp cloth for cleaning.

Exception: A product that is meant for uninterrupted service and that for some specific reason, such as the possibility of the loss of an authorization code for a CATV converter, is not intended to be unplugged by the user for cleaning or any other purpose, may exclude the reference to unplugging the appliance in the cleaning description otherwise required in item 5.

6. Attachments - Do not use attachments not recommended by the video product manufacturer as they may cause hazards.

7. Water and Moisture - Do not use this video product near water - for example, near a bath tub, wash bowl, kitchen sink, or laundry tub, in a wet basement, or near a swimming pool, and the like.

8. Accessories - Do not place this video product on an unstable cart, stand, tripod, bracket, or table. The video product may fall, causing serious injury to a child or adult, and serious damage to the appliance. Use only with a cart, stand, tripod, bracket, or table recommended by the manufacturer, or sold with the video product. Any mounting of the appliance should follow the manufacturer's instructions, and should use a mounting accessory recommended by the manufacturer.

8A.  An appliance and cart combination should be moved with care. Quick stops, excessive force, and uneven surfaces may cause the appliance and cart combination to overturn.

9. Ventilation - Slots and openings in the cabinet are provided for ventilation and to ensure reliable operation of the video product and to protect it from overheating, and these openings must not be blocked or covered. The openings should never be blocked by placing the video product on a bed, sofa, rug, or other similar surface. This video product should never be placed near or over a radiator or heat register. This video product should not be placed in a built-in installation such as a bookcase or rack unless proper ventilation is provided or the manufacturer's instructions have been adhered to.

10. Power Sources - This video product should be operated only from the type of power source indicated on the marking label. If you are not sure of the type of power supply to your home, consult your appliance dealer or local power company. For video products intended to operate from battery power, or other sources, refer to the operating instructions.

11. Grounding or Polarization - This video product is equipped with a polarized alternating-current line plug (a plug having one blade wider than the other).  This plug will fit into the power outlet in only one way. This is a safety feature. If you are unable to insert the plug fully into the outlet, try reversing the plug. If the plug should still fail to fit, contact your electrician to replace your obsolete outlet. Do not defeat the safety purpose of the polarized plug.

12. Power-Cord Protection - Power-Supply cords should be routed so that they are not likely to be walked on or pinched by items placed upon or against them, paying particular attention to cords at plugs, convenience receptacles, and the point where they exit from the appliance.

13. Protective Attachment Plug - The appliance is equipped with an attachment plug with overload protection. This is a safety feature. See Instruction Manual for replacement or resetting of protective device. If replacement of the plug is required, be sure the service technician has used a replacement plug specified by the manufacturer that has the same overload protection as the original plug.

14. Outdoor Antenna Grounding - If an outside antenna or cable system is connected to the video product, be sure the antenna or cable system is grounded so as to provide some protection against voltage surges and built-up static charges. Section 810 of the National Electrical Code, ANSI/NFPA 70, provides

information with regard to proper grounding of the mast and supporting structure, grounding of the lead-in wire to an antenna discharge unit, size of grounding conductors, location of antenna-discharge unit, connection to grounding electrodes, and requirements for the grounding electrode. See Fig.A.

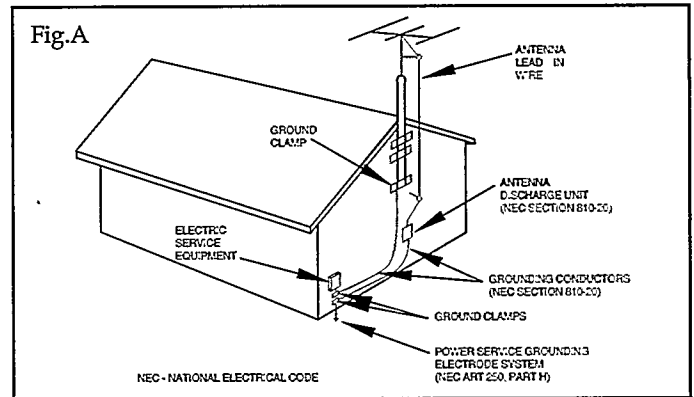

15. Lightning - For added protection for this product during a lightning storm, or when it is left unattended and unused for long periods of time, unplug it from the wall outlet and disconnect the antenna or cable system. This will prevent damage to the product due to lightning and powerline surges.

16. Power lines - An outside antenna system should not be located in the vicinity of overhead power lines or other electric light or power circuits, or where it can fall into such power lines or circuits. When installing an outside antenna system, extreme care should be taken to keep from touching such power lines or circuits as contact with them might be fatal.

17. Overloading - Do not overload wall outlets and extension cords as this can result in a risk of fire or electric shock.

18. Object and Liquid Entry - Never push objects of any kind into this product through openings as they may touch dangerous voltage points or short-out parts that could result in a fire or electric shock. Never spill liquid of any kind on the product.

19. Servicing - Do not attempt to service this product yourself, as opening or removing covers may expose you to dangerous voltage or other hazards. Refer all servicing to qualified service personnel.

20. Damage Requiring Service - Unplug this product from the wall outlet and refer servicing to qualified service personnel under the following conditions

- When the power-supply cord or plug is damaged.
- If liquid has been spilled, or objects have fallen into the product.
- If the product has been exposed to rain or water.
- If the product does not operate normally by following the operating instructions. Adjust only those controls that are covered by the operating instructions as an improper adjustment of other controls may result in damage and will often require extensive work by a qualified technician to restore the product to its normal operation.
- If the product has been dropped or the cabinet has been damaged.
- When the product exhibits a distinct change in performance - this indicates a need for service.

21. Replacement Parts - When replacement parts are required, be sure the service technician has used replacement parts specified by the manufacturer or which have the same characteristics as the original part. Unauthorized substitutions may result in fire, electric shock or other hazards.

22. Safety Check - Upon completion of any service or repairs to this product, ask the service technician to perform safety checks to determine that the product is in proper operating condition.

23. Carts and Stands - The appliance should be used only with a cart or stand that is recommended by the manufacturer.

24. Heat - The product should be situated away from heat sources such as radiators, heat registers, stoves, or other products that produce heat.

## LIMITED WARRANTY CD-I

- One (1) Year Free Labor
- One (1) Year Free Parts Service
- This CD-I must be shipped in for warranty service.

### Please keep...

...your sales receipt and other material proving proof-of-purchase. Attach it to this owner's manual and keep it nearby. Please also keep the original box and packing material should you ever need to ship your CD-I player to Philips for service.

### One (1) Year Coverage...

...starts from the date you bought your product. Both parts and labor are covered at no cost to you. Any defective part will be repaired or replaced. Any part is covered only for the original warranty period. Once the one (1) year warranty on the product has expired, the warranty on any replaced or repaired part also expires. Service for your CD-I is provided by shipping it to the Philips Factory Service Center (listed to the right) which specializes in this type of product.

After one year, you must pay for all labor, parts, transportation, and service charges.

### Who is Protected? ... Where?

Only the person who has proof-of-purchase will receive warranty service. This service will be provided to any product bought and used in the U.S.A., Puerto Rico, the Virgin Islands and Canada. If you move within these areas you must ship your monitor to the designated Philips Factory Service Center listed in this warranty.

### Before Calling for Service...

...please check your owner's manual. A check of the controls discussed there may save you a service call.

### How To Get Warranty Service

Due to the sophisticated nature of this product, warranty service will be provided by the Philips Personal Information Products Answer Center. If you feel you require warranty service for or need to discuss a problem about your CD-I, please contact the Philips Personal Information Products Answer Center at (800) 845-7301. There, a technician will go through a diagnostic check list with you and if it is determined the unit needs to be repaired, you will be given a return authorization number. Carefully pack the CD-I in secure packaging for safe shipment. It is recommended that you retain the carton and all packing materials from this unit. These materials are specifically designed and manufactured for shipping this product. Deliver or ship it freight prepaid and insured to the Philips Factory Service Center listed, with evidence of the purchase date and description of the problem. Following warranty repair, the unit will be returned to you freight prepaid. Be sure you include your complete return address on the outside of the carton.

### Warranty Exclusions - Your Warranty Does Not Cover...

...replacing or repairing your product because of misuse, accident, unauthorized repair, or other cause not within the control of Philips Consumer Electronics Company.

...incidental or consequential damages resulting from the product. Some states do not allow the exclusion of incidental damages, so the above exclusion may not apply to you.

...labor charges for installation or set-up, adjustment of customer or preference controls, and installation or repair of antenna systems outside the product.

...a product bought, used, or serviced outside the U.S.A., Puerto Rico, the Virgin Islands, and Canada.

...problems caused by signal or cable conditions outside the product.

### For product purchased in the U.S.A., Puerto Rico, or the Virgin Islands

#### How To Get Warranty Service:

If warranty service is required, you must ship your product with proof-of-purchase to a Philips Factory Service Center (listed below.)

**Philips Factory Service**  
5164 Blazer Parkway  
Dublin, OH 43017  
(614) 792-1495

IN THE U.S.A., PUERTO RICO, OR THE VIRGIN ISLANDS, ALL IMPLIED WARRANTIES INCLUDING IMPLIED WARRANTIES OF MERCHANTABILITY AND FITNESS FOR A PARTICULAR PURPOSE, ARE LIMITED IN DURATION TO THE DURATION OF THIS EXPRESS WARRANTY. Some states do not allow limitations on how long an implied warranty lasts, so the above limitation may not apply to you. This warranty gives you specific legal rights, and you may have other rights which vary from state to state.

**Philips Service Company**  
P.I.P. Information Center  
(800) 835-3506

### For product purchased in Canada

#### How To Get Warranty Service:

To obtain warranty service, the product must be delivered (carried-in) to a Philips Consumer Service Branch (listed below). These warranties are given in lieu of all other warranties. No other guarantees or warranties are expressed or implied, including any implied warranties of merchantability or fitness for a particular purpose. Philips shall not be liable under any circumstances for any direct, indirect, special, incidental or consequential damages, howsoever incurred, even if notified of the possibility of same.

All that's required to validate your original factory warranty is to present your bill of sale as proof of purchase.

**Philips Electronics Ltd.**  
601 Milner Avenue • Scarborough, Ontario M1B 1M8 •  
(416) 292-5161 5930 Côte de Liesse • Montréal, Québec  
H4T 1E1 • (514) 342-9180 3695 Grandview Hwy. •  
Vancouver, B.C. V5M 2G7 • (604) 435-4411

#### IMPORTANT REMINDER:

Please fill out and mail your warranty registration card promptly. It will be easier for us to notify you if it should ever be required. Please also keep your sales receipt and other proof-of-purchase information.

Please write in your model and serial numbers below. These numbers are located on your unit. Keep this manual nearby for easy reference.

Model No.: CDI450 / CDI550

Serial No.: \_\_\_\_\_



<b>SAFETY PRECAUTIONS</b> .....	3
<b>IMPORTANT SAFETY INSTRUCTIONS</b> .....	4
<b>LIMITED WARRANTY</b> .....	5
<b>CONTENTS</b> .....	7
<b>INTRODUCTION</b> .....	8
<b>INSTALLATION</b> .....	8, 9, 10, 11,12
<b>SETTING UP</b> .....	13
<b>PLAYING DISCS</b> .....	14, 15, 16
<b>BEFORE REQUESTING SERVICE</b> .....	17
<b>GLOSSARY</b> .....	18
<b>SPECIFICATIONS</b> .....	19

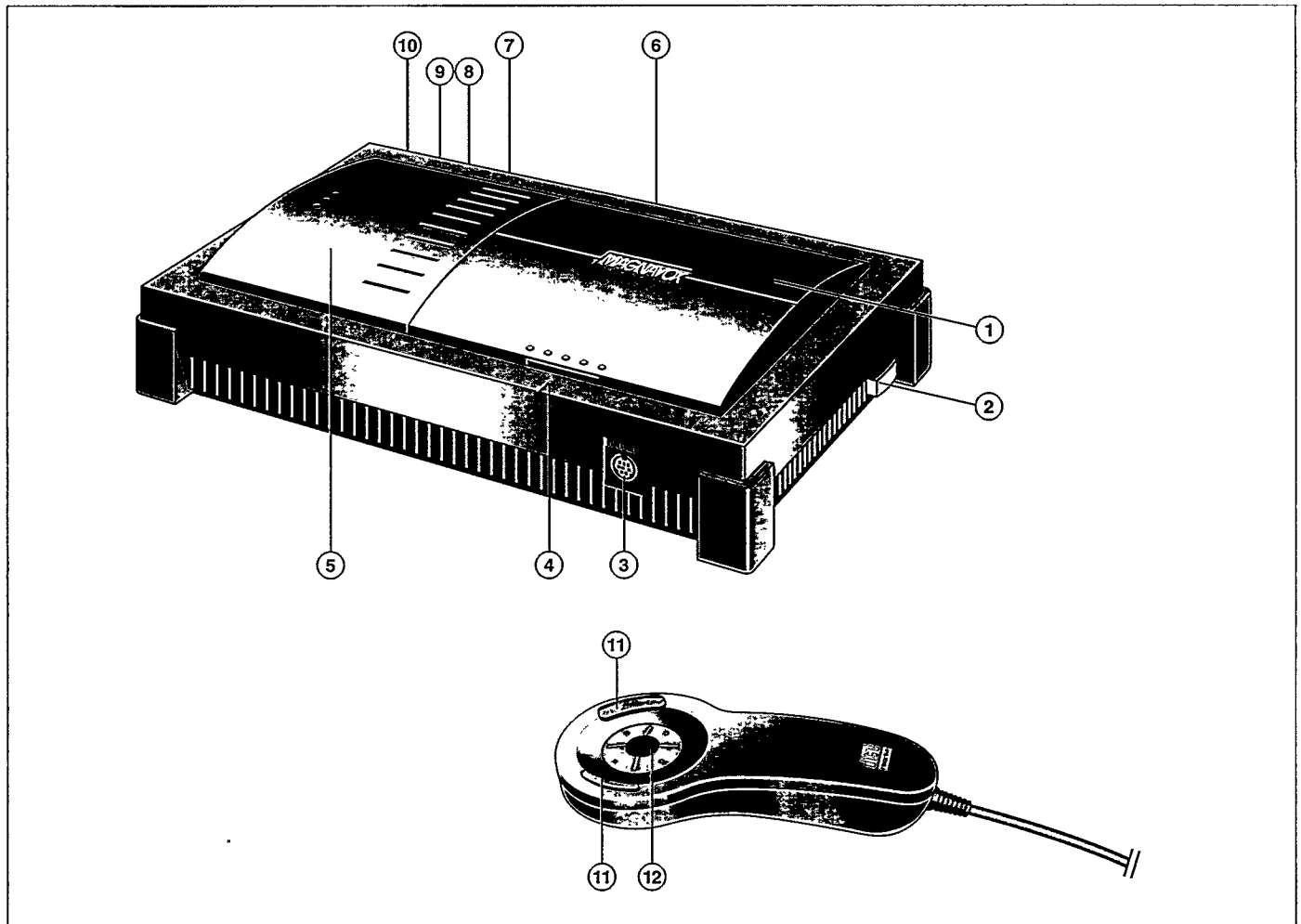

## INTRODUCTION

We are pleased to introduce you to one of the most innovative products available today: Compact Disc Interactive. You'll be surprised how easy it is! Once correctly hooked up to your TV, you simply 'point-and-click' to explore the intriguing new world of interactive Compact Disc.

Your CD-I player also plays CD-DA (audio compact discs) and audio tracks from both 5 - inch laser discs and CD-ROM discs. In addition it can play also one or more of the following disc types: Photo CD, CD-I Ready, CD Bridge and CD Graphics (CD+G).

By simply plugging in the optional Digital Video Cartridge, you can upgrade the player to run interactive Digital Video titles including movies, music videos and high-power action games as well as Video CD's.

A wide variety of optional accessories enhances its flexibility. Contact your supplier.

We are confident that you will find this product surprisingly easy to use, and uniquely innovative to operate.

## FRONT AND SIDE OF PLAYER

- 1 Disc cover.
- 2 ON/OFF button.
- 3 Input.
- 4 Power ON/READ IN indication.
- 5 Digital Video Cartridge cover.

## REAR OF PLAYER

- 6 DC IN.
- 7 DC OUT (for external RF-modulator only).
- 8 Audio R (right).
- 9 Audio L (left).
- 10 Video (CVBS).

## CD-I CONTROLLER

- 11 Action buttons.
- 12 Thumbpad.

### CAUTION

**NEVER MAKE OR CHANGE CONNECTIONS WITH THE POWER SWITCHED ON.**



# INSTALLATION

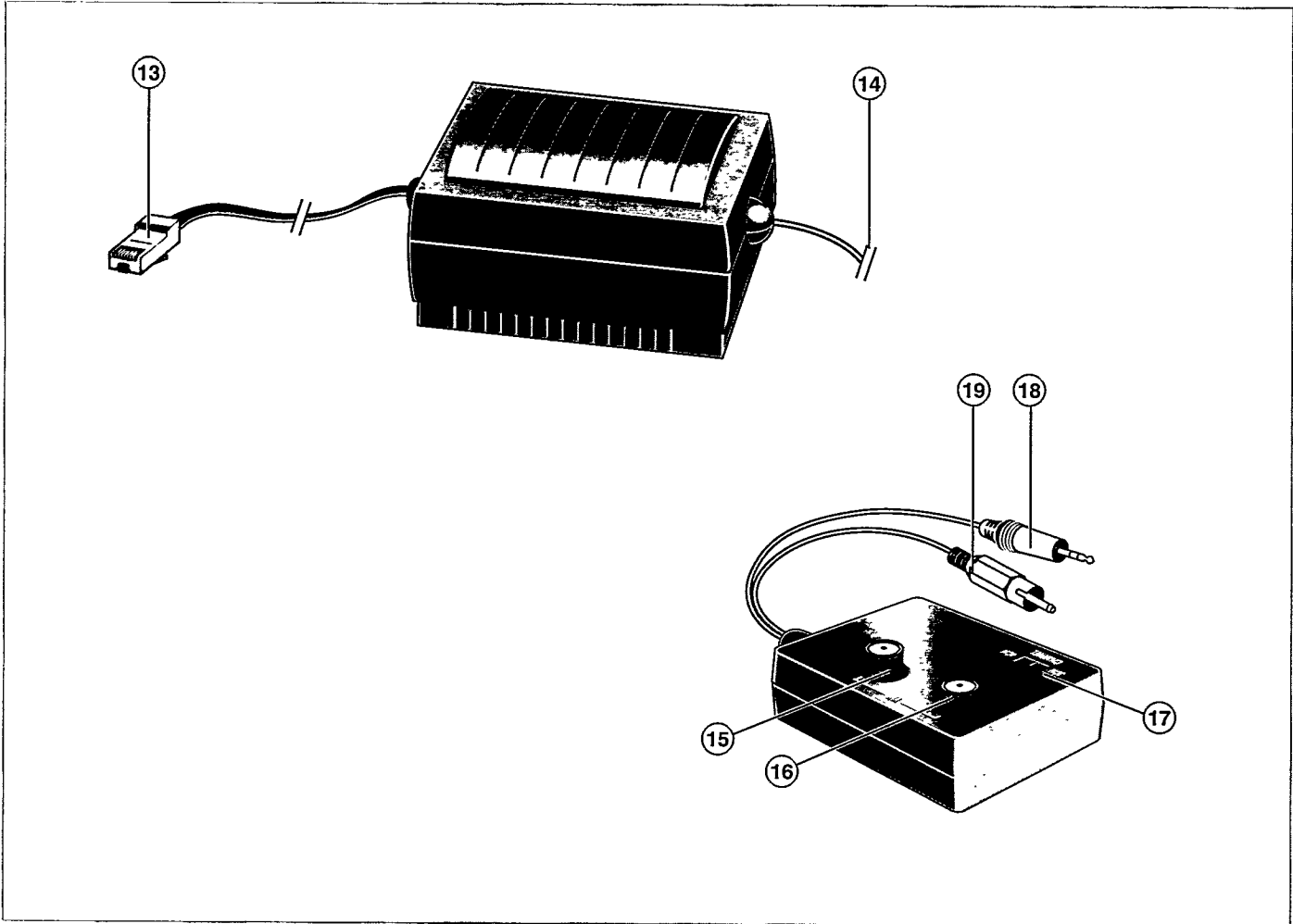

## POWER SUPPLY

- 13 DC output
- 14 Mains AC input.

## RF MODULATOR

- 15 ANT IN.
- 16 ANT OUT.
- 17 Channel Selector.
- 18 Audio/Power Cable.
- 19 Video Cable.

## PLACEMENT

- Place the player on a firm, flat surface.
- Keep away from heat sources and direct sunlight.
- In a cabinet, allow 2-3 cm (appr. 1") of free space around the circumference of the player for adequate ventilation.

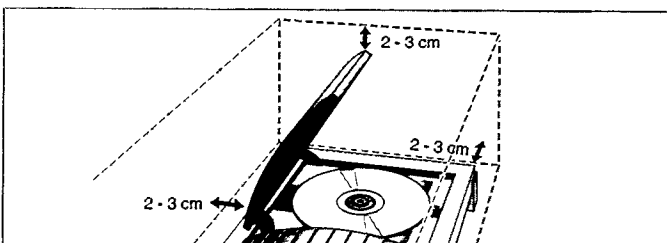

## POWER CONNECTION

- Connect the DC output (13) of the power supply into the DC IN (6) of the player.
- Insert the plug of the cord (14) into an AC outlet.

### NOTE

- The power supply automatically adjusts to the local power voltage.
- This power supply is intended to be used only with this CD-I player.

Only use the prescribed Power Supply:

- For USA use type 20PS301/17

### CAUTION

- **ONLY A QUALIFIED SERVICE PERSON SHOULD REMOVE THE COVER OTHER THAN THE DIGITAL VIDEO CARTRIDGE COVER OR ATTEMPT TO SERVICE THIS DEVICE.**
- **USE OF CONTROLS, ADJUSTMENTS OR PERFORMANCE OF PROCEDURES OTHER THAN THOSE SPECIFIED HEREIN MAY RESULT IN HAZARDOUS RADIATION EXPOSURE.**
- **NEVER MAKE OR CHANGE CONNECTIONS WITH THE POWER SWITCHED ON.**

# INSTALLATION

## 1. CHOOSING THE RIGHT VIDEO CONNECTIONS

Most of today's TV receivers have several possible picture input connections. In order of picture quality, these are:

- Video (CVBS).
- Antenna in.

Depending on the version of your player, it is advised that you connect it to the TV input with the highest picture quality.

### NOTE

Please refer to the instructions that come with the TV set for selection of the correct input.

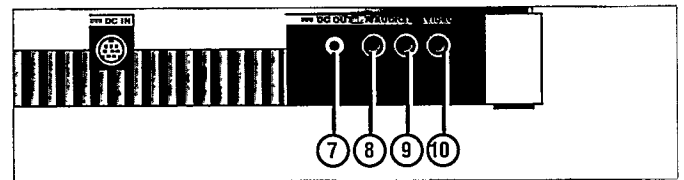

- 7. DC OUT.
- 8. Audio R (right).
- 9. Audio L (left).
- 10. Video (CVBS).

For any optional connection accessories you require, contact your supplier.

## 2. CONNECTION TO A TV WITH A VIDEO (CVBS) SOCKET

- Connect the corresponding connectors with a matching video cable.
- Since this cable does not connect the audio, it has to be connected separately with a matching cable (refer to the accessories page on the back of this manual).

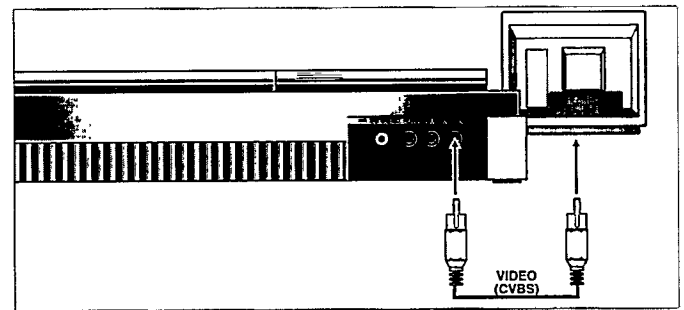

## 3. EXTERNAL RF MODULATOR CONNECTION

- Connect the Audio/Power cable and the Video (CVBS) cable of the RF modulator unit to the corresponding connectors of the player.
- Disconnect the input cable from the antenna at the TV and plug it into the ANT IN socket of the RF modulator.
- Link the modulator's ANT OUT socket with the TV using the RF cable.
- If you have a VCR (or antenna or cable) connected to the TV antenna input and your RF modulator has an antenna input, connect the RF modulator between the VCR (or antenna or cable) antenna output and the TV antenna input. You may also use an optional external switchbox, if desired.
- Your CD-I player sends pictures and sound to your TV on the channel number indicated by the channel selector position at the RF modulator. This signal is sent through the coaxial cable.
- To operate the player with your TV, set your TV to the same channel.
- You can avoid local interference by selecting a different channel with the channel selector.

Please refer to the instructions that came with the TV set for the selection of the channel.

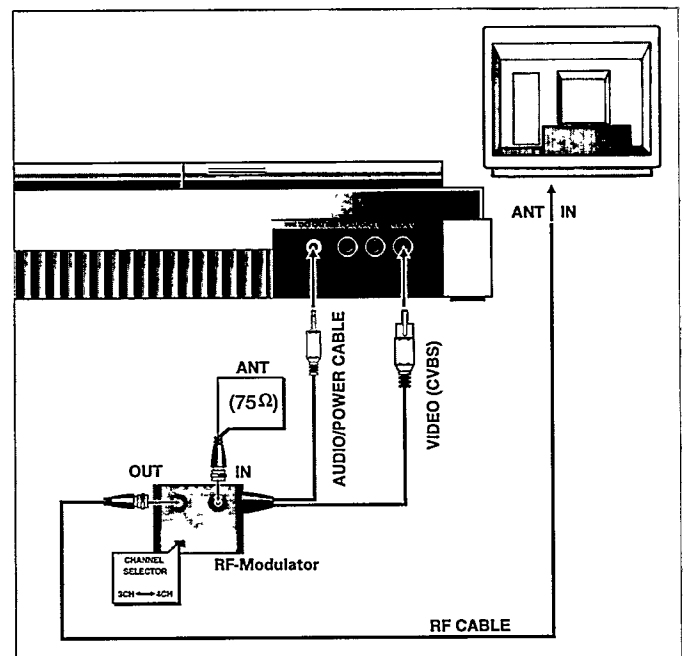

## 4. AUDIO CONNECTIONS

- If you use the video (CVBS) (10) output, you also will need to connect the player's audio output (8,9) to the TV's audio input.

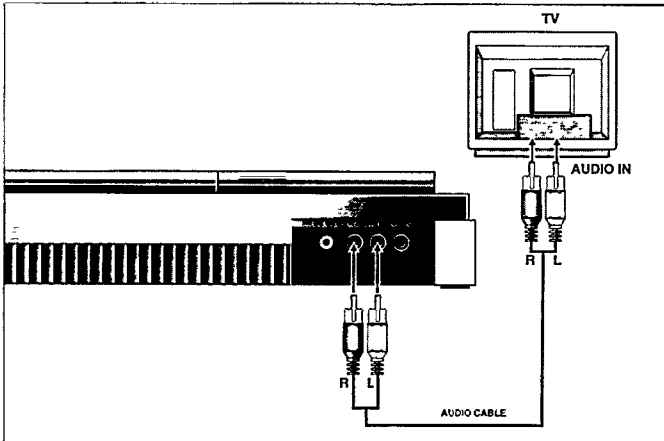

**NOTE**

- The sound sent through the RF output to your TV is mono only.

- For HiFi sound, you can connect the player's audio output (8,9) to the input of your HiFi system.

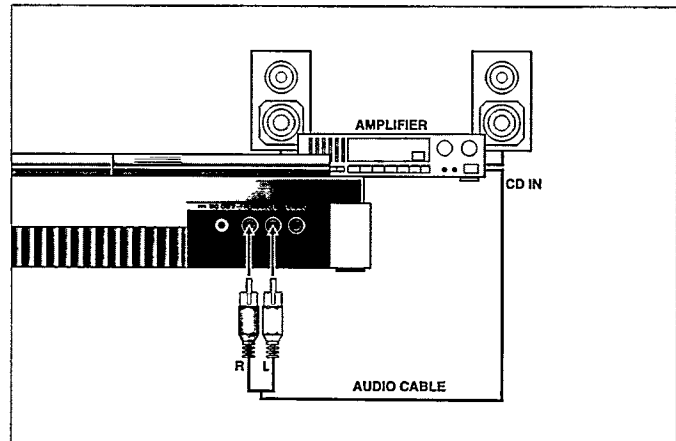

**CAUTION**

**DO NOT CONNECT THE PLAYER'S AUDIO OUTPUT TO THE HIFI PHONO (RECORD PLAYER) INPUT.**

## 5. POINTING DEVICE CONNECTION

**INCLUDED POINTING DEVICE:** The CD-I Controller

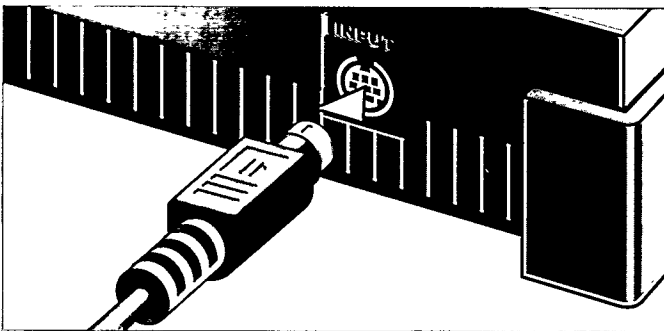

- To operate your CD-I player:
  - A pointing device is needed.
  - Plug the CD-I controller connector into the CD-I player .
  - Insert the connector with the arrow at the top.
  - Then you can switch on the player.
  - Move the cursor in the direction you want by pressing in that direction on the thumbpad.
  - Click on one of the action buttons.
- The function selected by this "point-and-click" technique is highlighted to confirm the selection.

**OPTIONAL DEVICES:** Roller Controller, Trackerball, Mouse, Touchpad, CD-I Controller, IR-Remote kit, Splitter (refer to the accessories page on the back of this manual).

**NOTE**

To "point-and-click" on any screen shown in this manual, any one of the two action buttons of the pointing device can be used. The shape of the cursor may be different depending on the program you are playing, but it is always controlled in the same way.

Pointing devices are sensitive precision instruments. Handle them with care, keeping in mind the following precautions:

- Avoid dropping or knocking.
- Do not use them in locations subject to extreme temperatures, humidity, dust or vibration.
- Never hold the pointing device by the cable.
- Never pull the cable to disconnect the pointing device from the player.

**CAUTION**

**NEVER MAKE OR CHANGE CONNECTIONS WITH THE POWER SWITCHED ON.**

# INSTALLATION

## 6. INSTALLING A DIGITAL VIDEO CARTRIDGE (\*)

### INTRODUCTION:

As soon as you have plugged this cartridge into your CD-I player, you can play the latest CD-I discs, featuring interactive movies, music videos and state-of-art video games and video CD's. Enjoy yourself! But first.....

*Note: A special tool is supplied with the cartridge. Keep it safe in case you need it.*

### CAUTION - WHILE INSTALLING (OR REMOVING) YOUR CARTRIDGE:

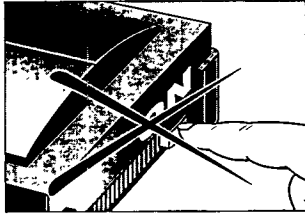

Make sure the player is switched off!

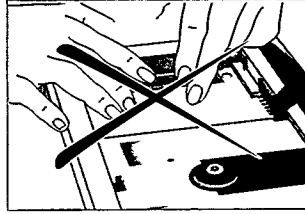

Do not touch the cartridge connector!

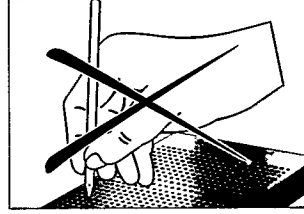

Do not probe into the ventilation holes!

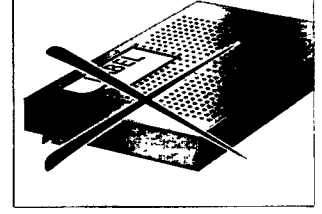

Do not block the ventilation holes!

### INSTALLATION:

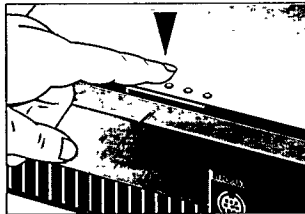

Open the disc cover.

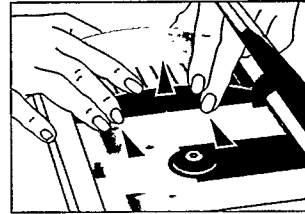

Push at the latches (side) to open the Digital Video Cartridge cover.

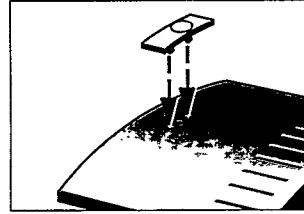

Mount the Digital Video Cartridge identification badge on the Digital Video Cartridge cover.

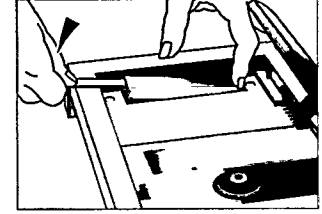

Remove the metal protection of the connector in the player with the supplied tool. (Keep it for possible future use). Do not touch the connector.

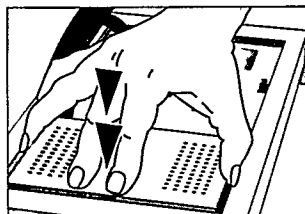

Plug in the Digital Video Cartridge.

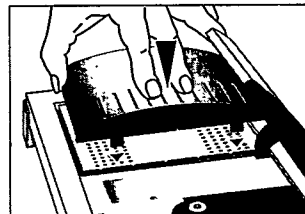

Reinstall the Digital Video Cartridge cover.

**THE CARTRIDGE IS NOW INSTALLED AND SHOULD NOT BE REMOVED WITHOUT CAUSE: IT CARRIES A LOT OF EXTRA MEMORY WHICH IS VALUABLE EVEN FOR TITLES WITHOUT DIGITAL VIDEO (FULL-MOTION).**

### REMOVAL:

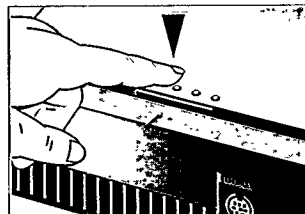

Open the disc cover.

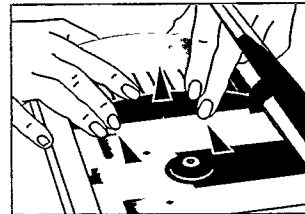

Push at the latches (side) to open the Digital Video Cartridge cover.

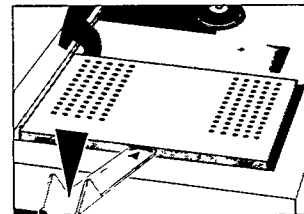

Remove the Digital Video Cartridge with the supplied tool.

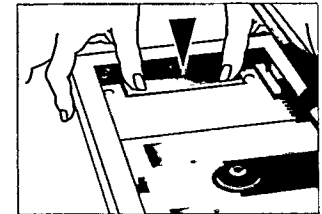

Reinstall the metal protection. Do not touch the connector.

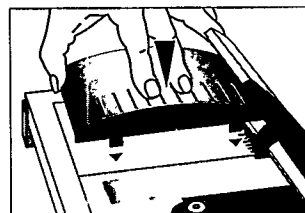

Reinstall the Digital Video Cartridge cover.

### BEFORE REQUESTING SERVICE!

- IF THE PLAYER MALFUNCTIONS AFTER CARTRIDGE INSERTION, TRY REMOVING AND REINSERTING IT.
- DO NOT ATTEMPT REPAIRS: THIS WILL INVALIDATE THE WARRANTY.

(\*) OPTIONAL WITH CDI450  
SUPPLIED WITH CDI550

## SWITCHING ON AND OFF

- Press the ON/OFF button (2) to switch the player on.
  - The green LED lights up.
  - Switch on the TV (and HiFi system if used).
  - Select the CD-I input on the TV (and HiFi system if used).
- On the TV, the player start-up screen will appear. This screen has the following system function icons to guide and assist you:

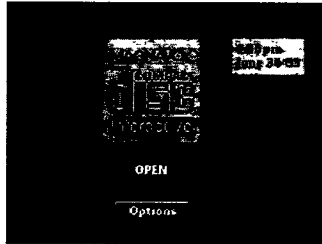

- Press the ON/OFF button (2) to switch the player off.
- Switch off the TV (and HiFi system, if used).

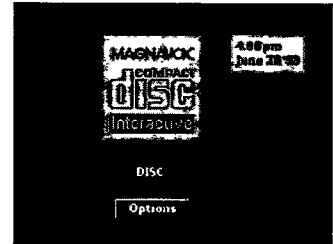

**Options:**  
See: "OPTIONS SCREEN".

**System information:**  
OPEN: Indicates that the disc cover is open (or not fully closed).  
DISC: Means that there is no disc in the player or the disc can not be read due to damages or dirt (refer to p.17)

## OPTIONS SCREEN

### 1. CD Audio

To preselect your preferred settings when playing audio CDs:

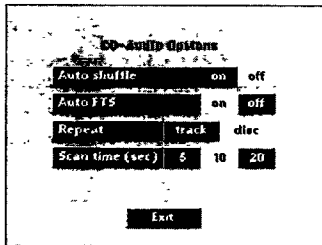

#### Auto shuffle

After switching the player on, the tracks on the CD will automatically be played in a random order.

#### Auto FTS

After switching the player on, the FTS program of the CD will be played automatically.

#### Repeat

Select to repeat a complete audio disc or a single track when the repeat function is activated.

#### Scan time

Select the time you want the beginning of each audio track to play (5, 10 or 20 seconds) when the scan function is activated.

- When finished, point-and-click on 'Exit'.

### 2. General

To change the players general settings:

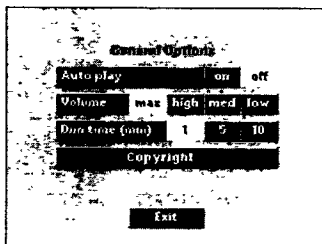

#### Auto play

After switching the player on, playback will start automatically when a disc is loaded.

#### Volume

Selecting the player default volume setting

#### Dim Time (min)'

On all screens shown in this manual except CD Graphics screen, dim occurs automatically after 1-5-10 minutes if the player is not used.

Dim greatly reduces the brightness of the displayed picture. The normal brightness is restored by any user action with the control device(s).

- When finished, point-and-click on 'Exit'.

### 3. Time and Date

To change the player's time and date settings:

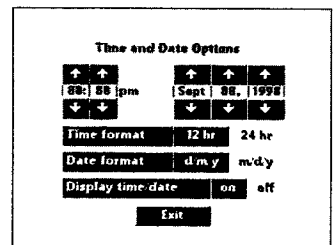

#### Time/Date set

If the time or date shown on the screen is wrong, select the appropriate ▲ and ▼ arrows to set hours, minutes, day, month and year in turn, as required.

#### Time format

Select 24 hour or 12 hour clock.

#### Date format

Select d/m/y to present the date in day-month-year sequence. Select m/d/y to present the date in month-day-year sequence.

#### Display time/date

Select to display the time and date on the TV screen.

- When finished, point-and-click on 'Exit'.

### 4. Storage

Use to refer to the intermediate results of CD-I titles and of programs created for your audio and Photo CDs.

The "Storage" screen shows the information held in memory: titles, dates and percentage of memory used.

Clicking on "Name", "Date" or "Size" sorts the information accordingly.

- Use the scroll arrows to move up and down the list.
- To delete an item, click on its title and then click on "Delete". If you change your mind after deleting, click on "Undo".

- When finished, point-and-click on 'Exit'.

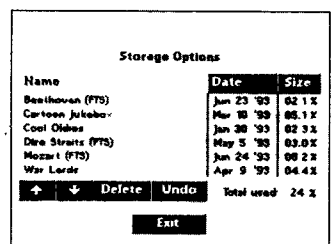

# PLAYING DISCS

## LOADING AND UNLOADING

### Loading:

- Push on the disc cover (1) to open.
- The disc cover unlatches.
- Open the cover gently until it is in the open position (60° approx.) where it latches.
- Take the disc and place it in the player with the label up.
- Push the disc cover (1) to close.
- The LED flashes whilst the disc is starting up and lights stable when the disc is ready for play.
- The TV screen changes according to the type of disc.

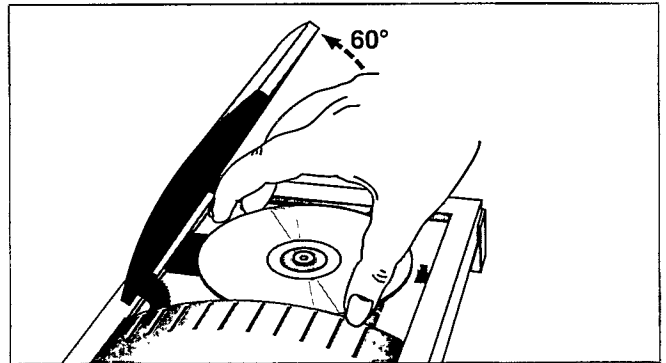
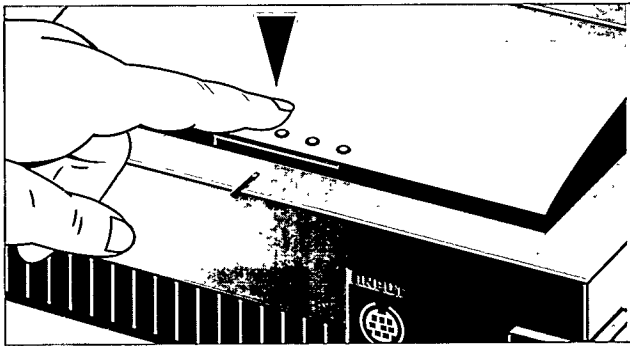

### Unloading:

- Push on the disc cover (1) to open.
- The player start-up screen reappears on the TV.
- Take the disc from the player.
- Push the disc cover (1) to close.

### NOTE

- Unloading a CD-I disc while the CD-I program is running, will terminate the CD-I program abruptly. 'Bookmarks' or intermediate results, if used by the CD-I program, might not be updated to reflect the latest situation.

### CAUTION

**NEVER PUT MORE THAN ONE DISC AT A TIME INTO THE CD-I PLAYER**

## PLAYING A CD-I DISC

### NOTE

This procedure is the same for CD BRIDGE discs, CD-I READY discs and PHOTO CDs. It is also the same for Digital Video discs and Video CDs when a Digital Video Cartridge has been installed.

### CAUTION

**– NEVER LEAVE A STILL PICTURE ON THE SCREEN FOR ANY LENGTH OF TIME. THIS CAN CAUSE BURNING-IN OF THE PICTURE TUBE. IN SUCH A CASE, SWITCH OFF THE PLAYER OR REMOVE THE DISC.**

- When a title consists of more than one consecutive disc, a so called 'multi-disc' title, follow the instructions for opening and closing the disc cover as shown on this screen.

Certain aspects of CD-I disc playback depend on the value of Auto play (see settings). The factory setting is default "ON".

### 1. When autoplay is "ON":

After loading the disc, the CD-I program will start up automatically.

### 2. When autoplay is "OFF":

After loading the disc, the CD-I start-up screen will appear on the TV.

To start the CD-I program, select the 'Play' icon on the screen and click on it.

The opening screen of the CD-I program now appears on the TV. From this point, all interaction is between you and the program. To stop at any time, select the STOP or EXIT function provided by the CD-I program.

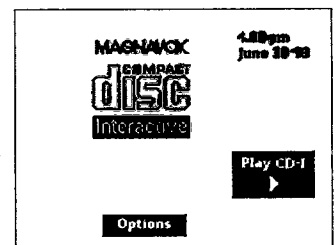

## PLAYING AN AUDIO CD

### I. Using the audio screen

**NOTE:** This procedure also can be used for audio sections on 5 inch (12 cm) laser discs.

– After loading the disc, the CD-Audio screen appears on the TV.

**1. Play track bar:** shows the total number of tracks (up to 30). You can 'point-and-click' to select any track. For discs with more than 30 tracks, the right ► and left ◀ scroll arrows are used to move through the track list.

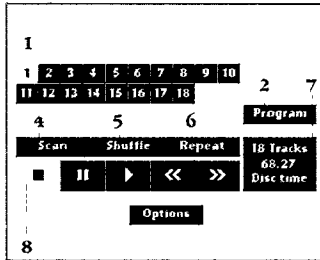

**2. PROGRAM:** allows you to program a list of special tracks, called a Favorite Track Selection. When you select PROGRAM, the FTS track bar and the FTS icon will appear.

**3. FTS:** allows you to play Favorite Track Selections. This icon only appears if a Favorite Track Selection has been created for the disc that is loaded in the player.

**4. SCAN:** allows you to listen to the beginning of every track listed in the play track bar. You can set the scan time to 5, 10 or 20 seconds by using the 'Options' screen.

**5. SHUFFLE:** allows you to play the tracks in the play track bar in a random order.

**6. REPEAT:** allows you to repeat either one track or the entire disc. You can change the repeat mode in the 'Options' screen.

**7. TRACK/TIME window:**

– after loading, and in STOP mode, this shows the total number of tracks and the total playing time. When you click on this window (7), the track time of the selected track is displayed.  
– in PLAY and PAUSE modes, the window shows the track number and either the elapsed or the remaining track playing time. To switch between elapsed and remaining time, 'point-and-click' at the time shown in the window.

**8. All the disc play control functions are shown on the screen, and can be selected as desired by 'pointing-and-clicking' with your pointing device. The operation of the functions is briefly explained in the following table.**

#### NOTE

If auto SHUFFLE or auto FTS has been selected on the 'CD Audio' screen, this function will be activated automatically.

OPERATION	SELECT
<b>Start play</b>	<b>play</b> play starts at the beginning of track 1, or any other preselected track number. If a track is already playing, it is restarted. <b>NOTE:</b> When play starts, adjust the sound level as required.
<b>Select a track</b>	<b>track number</b> if the disc contains more than 30 tracks, use the left ◀ and right ► scroll arrows to move through the track numbers as required.
<b>Pause</b>	<b>pause</b> interrupts the play mode.
<b>Exit pause</b>	<b>pause or play</b> play restarts at exactly the same point as that at which pause was selected.
<b>Forward search</b>	<b>forward</b> searches forward through disc, first slowly, then quickly.
<b>Reverse search</b>	<b>reverse</b> searches backwards through disc, first slowly, then quickly.
<b>Stop play</b>	<b>stop</b> use to stop playing.
<b>Scan the disc</b>	<b>scan</b> plays the beginning of each track on the disc in turn.
<b>Exit scan</b>	<b>scan</b> normal play starts from this point.
<b>Shuffle play</b>	<b>shuffle</b> shuffle sequence appears in track bar.
<b>Exit shuffle</b>	<b>shuffle</b> normal play starts from this point.
<b>Repeat</b>	<b>repeat</b> repeats the entire disc (or FTS program), or the track being played, as selected on the "Options" screen.
<b>Play FTS</b>	<b>FTS</b> only available when an FTS program has already been created for the disc in the player.
<b>Exit FTS</b>	<b>FTS</b> normal play starts from this point.
<b>Program FTS</b>	<b>program</b> <ul style="list-style-type: none"> <li>• Point to tracks as required on the play track bar, and in each case click on any action button to record the track in the FTS track bar.</li> <li>• To cancel an unwanted track, point to it in the FTS track bar and click on any action button.</li> <li>• To cancel the entire FTS program, point to the first track in the FTS track bar and click on any action button repeatedly until all the tracks disappear.</li> </ul>
<b>Store FTS</b>	<b>save FTS</b> the keyboard screen replaces the CD-Audio screen. See 'CREATING FTS TITLES', p 16.

# PLAYING DISCS

## PLAYING AN AUDIO CD

### 2. Creating FTS titles

- After creating a Favorite Track Selection for a disc, you can compose a title of approx. 30 characters (depending on the character width) for the selection using the keyboard screen.
- The title then appears on the CD-Audio screen whenever the disc is loaded.
- At the CD-Audio screen, 'point-and-click' on the program button, then 'point-and-click' on the "Save FTS" button.
- The CD-Audio screen will change to the keyboard screen.
- Select each character of the title in turn, using shift to change between upper and lower case characters and space to separate words.

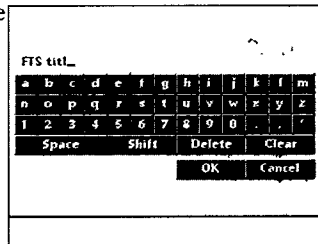

- Delete erases the last selected character.
- Clear erases the complete (or partially complete) title.
- Cancel returns to the CD-Audio screen without saving the title.
- OK saves the title and returns to the CD-Audio screen.

## PLAYING AN AUDIO CD

### 3. CD graphics

- When an audio CD with graphics is played, the CD Graphics screen will appear automatically.
- To let the picture channel bar appear/disappear, click on the action button anywhere outside the channel bar.
- You can select another track number by clicking on "Track" or either arrow next to it.
- Depending on the disc, other channel numbers might give you other information, such as the lyrics in a different language.
- Refer to the instructions that came with the disc for their functions.
- To play audio only, click on the 'Audio' icon.

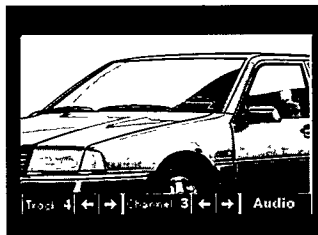

#### CAUTION

NEVER LEAVE A STILL PICTURE ON THE SCREEN FOR ANY LENGTH OF TIME. THIS CAN CAUSE BURNING-IN OF THE PICTURE TUBE. IN SUCH A CASE SWITCH OFF THE PLAYER OR REMOVE THE DISC (SEE DIM OPTIONS).

## PLAYING A PHOTO CD

- After loading the disc, the CD-I start-up screen appears on the TV.
- To start the Photo CD program, select the 'PLAY CD-I' icon on the screen.
- The opening screen of the Photo CD program now appears on the TV.
- At the bottom of this screen a menu bar with icons is shown.



- Select the icon.
- The 'Options' screen will now appear.
- To select a language, click on the box, the flag or the name of a country.
- The previous setting will be replaced automatically.

- Select the icon (Return) on this screen to go back to the Photo CD opening screen.



- Select the icon (Information) and the INFORMATION screen, explaining the control buttons of the menu bar in the selected language, appears.
- From this point, all interaction is between you and the program.

#### CAUTION

NEVER LEAVE A STILL PICTURE ON THE SCREEN FOR ANY LENGTH OF TIME. THIS CAN CAUSE BURNING-IN OF THE PICTURE TUBE. IN SUCH A CASE SWITCH OFF THE PLAYER OR REMOVE THE DISC. (SEE DIM OPTIONS).



# BEFORE REQUESTING SERVICE

If it appears that the CD-I player is faulty, first consult this checklist.

It may be that something simple has been overlooked.

Under no circumstances should you attempt to repair the system yourself; this will invalidate the warranty.

- No power** ..... • Check that the ON/OFF button (2) is set to ON.  
• Check that both plugs of the power supply are properly connected.  
• Check that there is power at the AC outlet by plugging in another appliance.

- Controller does not operate** ..... • Reset by switching player off, then on again.

- No picture** ..... • Check that the TV is switched on.  
• Select the same channel or input on the TV as that of the player or check the video connection.

- Distorted picture** ..... • Check the disc for fingerprints and clean with a soft cloth, wiping from centre to edge.

- Interference pattern on TV** ..... • Avoid close position of video and audio cables to power supply.

- White dots on the screen** (only for RF).  
..... • Check the position of the power supply and RF modulator (cables). Avoid close position.

**No start-up.**

- Screen does not change** ..... • Check if the disc door is properly closed.  
• Make sure the disc label is facing up.  
• Clean the disc.  
• See if the disc is defective by trying another disc.

- No sound** ..... • Check audio connections.  
• If using a HiFi amplifier, try another sound source.

- Distorted sound from HiFi amplifier** ..... • Check to ensure that audio connections have not been made to the amplifier Phono input.

- No return to start-up screen when disc is removed** ..... • Check to see if the CD-I program requires another disc to be loaded.  
• Reset by switching the player off, then on again.

# GLOSSARY

For your convenience, the following list of terms is provided to help you understand the CD-I Player and its operation.

**ACTION BUTTON** – Two keys on the pointing device to perform actions or features.

**AUDIO OUT** – There are two jacks located on the back of your CD-I Player. They are used to send audio (sound) from the Player to either the TV, Stereo Receiver, or Amplifier. You could also hook it up to a VCR (Video Cassette Recorder) or Audio Cassette Recorder to record sound sent out from your Player.

**CD, CD-DA, or CD-AUDIO** – Terms used to describe a disc that produces only audio (sound) for your CD-I Player.

**CD** = Compact Disc

**CD-DA** = Compact Disc-Digital Audio

**CD-Audio** = Compact Disc Audio

**DIGITAL VIDEO DISCS and VIDEO CD'S** – These discs can only be played when a Digital Video cartridge is installed.

**CD GRAPHICS** – a technique for generating text, still pictures, or animated graphics that are related to the sound portion of the Compact Disc (CD).

**CD-I** – Compact Disc Interactive. A type of disc with both pictures and sound. Interacting with the disc allows you to tailor it to your taste.

**CD-I PLAYER** – Compact Disc Interactive Player. A device that allows you to play several types of discs, including CD-I, CD, Photo-CD and CD-ROM XA (Bridge).

**CD-ROM-XA (Bridge)** – One of several types of discs you can play in your CD-I Player.

**CURSOR** – Moving spot, controlled by your pointing device, shaped as an arrow or something else according the program you are playing, to guide you across the screen.

**FEATURE** – A task the CD-I Player can perform. For example, the Dim feature of the Player will dim your TV screen if it is selected.

**ICON** – a display on one of the CD-I shell screens. The icon shows where to place the arrow. Press on one of the ACTION buttons to begin that feature. Example: "PLAY CD-I ►" on the CD-I screen. Place the arrow on top of the "►" and click on one of the ACTION buttons and the CD-I starts playing.

**MODE** – The operating condition or status of the CD-I Player. This is determined by the function currently engaged and/or the setting selected. For example, "Play mode".

**PAUSE** – Temporarily stopping play of a CD-Audio. When in the Play mode, press the PAUSE button to put the CD-I Player in the Pause mode.

**PHOTO-CD** – A type of compact disc on which photographs have been stored.

**PLAY** – The act of the Player taking the picture and/or sound from a disc and sending it to your TV and/or Stereo Receiver or Amplifier. You must press the PLAY button or select the PLAY icon before the Player will start reading a disc.

**RF COAXIAL CABLE** – Black, insulated, round cable used to connect the RF-modulator to the TV antenna input.

**RF MODULATOR** – Converts the audio and video output signal of the CD-I player to a RF-signal which can be fed into your TV's antenna input.

**SCREENS** – Word used when discussing with your TV. For example, "TV screen" refers to the area on the TV for viewing pictures. Word also used when discussing CD-I Player display screens. For example, the "CD-I Player Start-Up screen." These screens allow you to select functions you want the Player to perform.

**STOP** – Ending play of a disc. When in the Play mode, press the STOP button to end play of a CD-Audio.

**THUMBPAD** – The part of the pointing device used to guide the arrow across the screen. Place the arrow on top of the icon of a feature you want to perform.

**TRACKS** – Disc sections varying in length. There can be many tracks on one disc, with each track a distinct unit. Tracks are important in using the Scan and Shuffle features.

**VIDEO OUT** – There is one jack on the back of your CD-I Player that can be used to send pictures (video) to your TV. You could also hook it to a VCR (Video Cassette Recorder) to record pictures sent out from the Player.

**VOLUME** – The amount of sound you hear.

**POINTING DEVICE** – By pressing the buttons, signals are sent to the CD-I player to perform desired actions. For example PLAY.

# SPECIFICATIONS

**System**  
CD-Interactive

**Usable discs**  
CD-I  
CD-DA  
PHOTO-CD  
CD-I READY  
CD BRIDGE  
CD+GRAPHICS

**Power requirement**  
120 V AC / 60 Hz.

**Power consumption**  
28 W with, 21 W without Digital Video Cartridge (22ER9956).

**Operating temperature**  
41°F(5°C) to 95°F(35°C)

**Relative humidity**  
5% to 95% (no condensation)

**Weight**  
With Digital Video Cartridge: 1,460 Kg, 0,661 lbs.  
Without Digital Video Cartridge: 1,210 Kg, 0,548 lbs.

**Dimensions (w x h x d)**  
**Cover closed:** 299 mm x 67 mm x 190 mm  
11,75" x 2,64" x 7,5"  
**Cover open:** 299 mm x 183 mm x 190 mm  
11,75" x 7,32" x 7,5"

**Input**  
input (1 ports) 8-pin mini-DIN  
suitable for connection of max. 2 devices (when splitter  
is used). e.g. 2 pointing devices



pin	signal	I/O
1	rxd1	I
2	rxd2	I
3	txd1	O
4	rts1	O
5	ground	-
6	cts1	I
7	rts2	O
8	+5V (150 mA max.)	O

Note: Pointing device speed of 1200 baud is supported.  
Designs and specifications are subject to change without notice.

**Output**  
video (NTSC) 1 Vpp (75 Ohm load, sync neg) RCA jack socket.

audio 2 Vrms  
2 channel individual RCA jack sockets

Audio-Power Cable:

RF Power + 5V, max. 50 mA  
Audio Audio(mono); 1.55 Vrms

# ACCESSORIES

## SUPPLIED ACCESSORIES

These accessories are provided to help you use or set-up your CD-I Player.

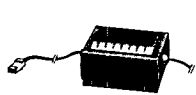

Power supply  
22ER9156/17

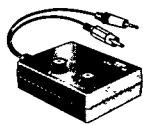

RF Modulator\*  
22ER9071/17

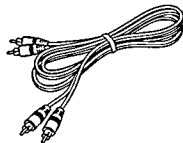

Audio L-R Cable  
SBA2135A01

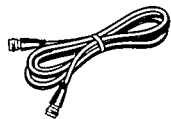

Antenna Cable\*  
(RF coaxial cable)  
SBV1130A01



CD-I Controller  
22ER9019

## OPTIONAL ACCESSORIES

Maximize your pleasure with state-of-the-art accessories designed specifically for your CD-I Player.

The optional accessories shown here may be purchased from your supplier.

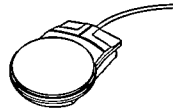

CD-I Mouse  
22ER9011



Roller Controller  
22ER9012

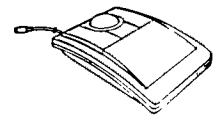

CD-I Trackball  
22ER9013



Digital Video  
Cartridge\*\*  
22ER9956



I/O Port Splitter  
22ER9208



Touchpad  
22ER9017

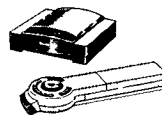

IR set (Receiver +  
Rem. Control)  
22ER9054

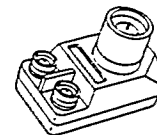

300 ohm - 75 ohm  
Transformer  
00SBV1113A01

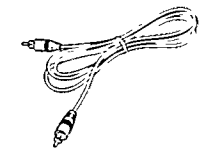

Video (CVBS)  
Cable  
SBV1127A01



Connection kit  
22ER9155/17

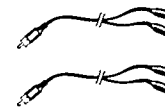

Audio Stereo  
Splitter  
22ER9209

type no. of product  
CDI 450

Date of purchase

day month year 19

\* available on some player versions only.

\*\* supplied with CDI550

The products and services described herein are not necessarily available in all countries

©1994 PHILIPS INTERACTIVE MEDIA SYSTEMS

Dealer's name, address and signature

Due to continuous product improvements this document is subject to change without notice

Printed in Belgium 3104 125 21041

IB7108E001